

1

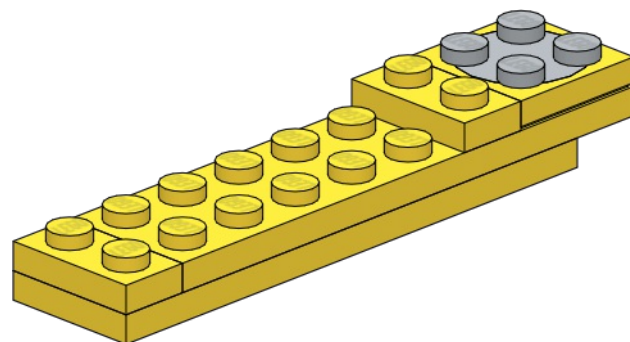

2

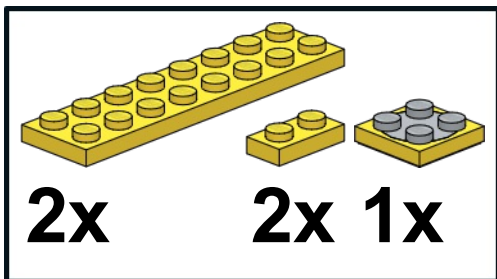
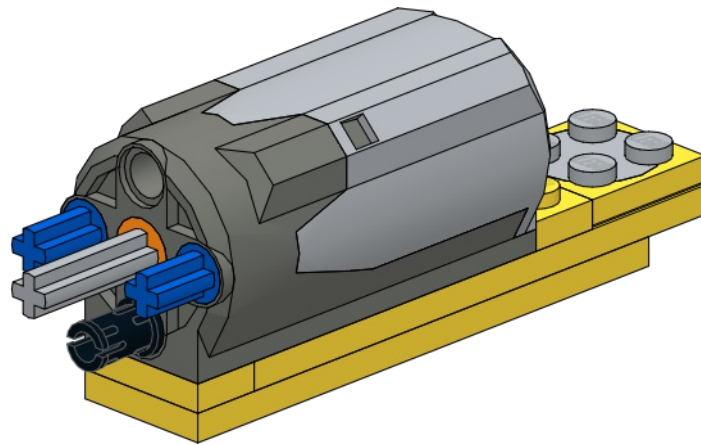
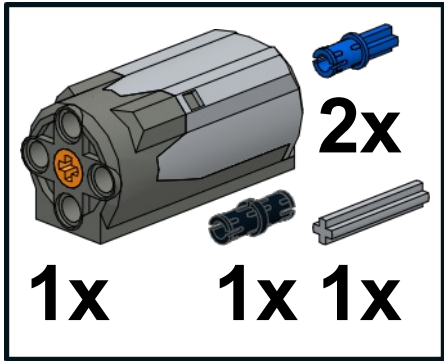

3

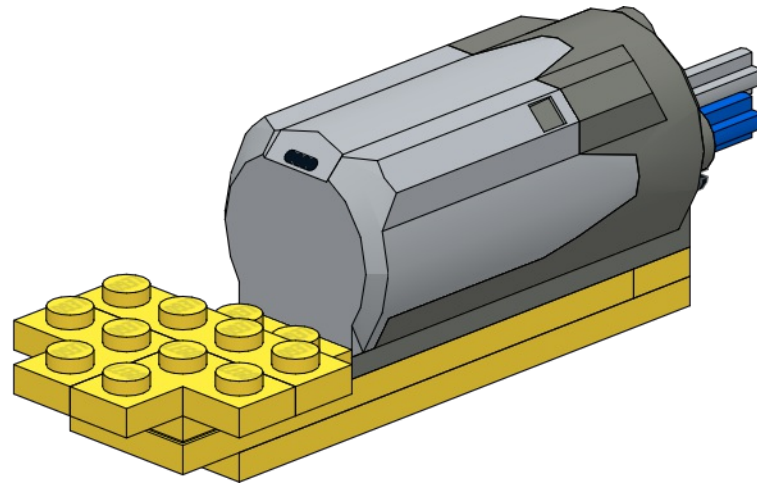
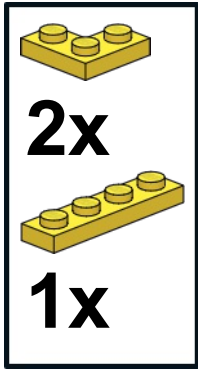

4

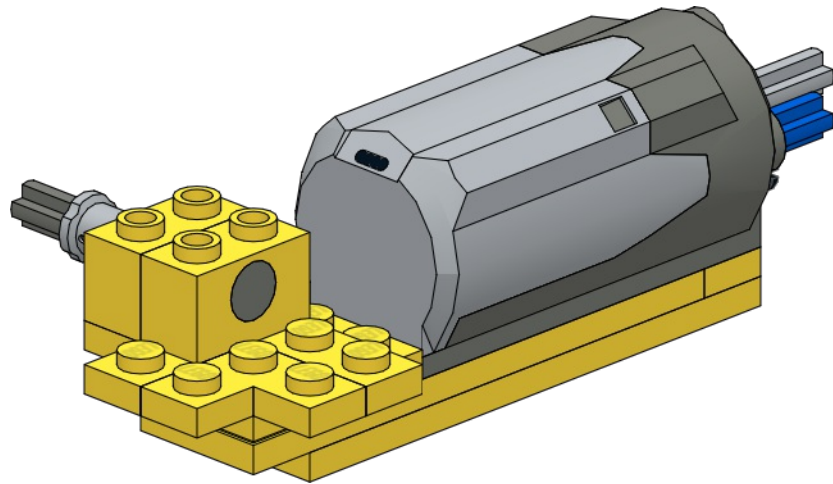
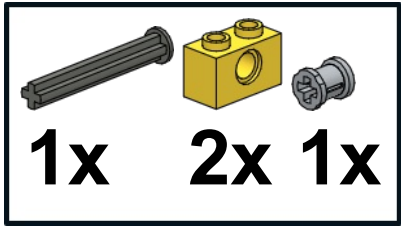

5

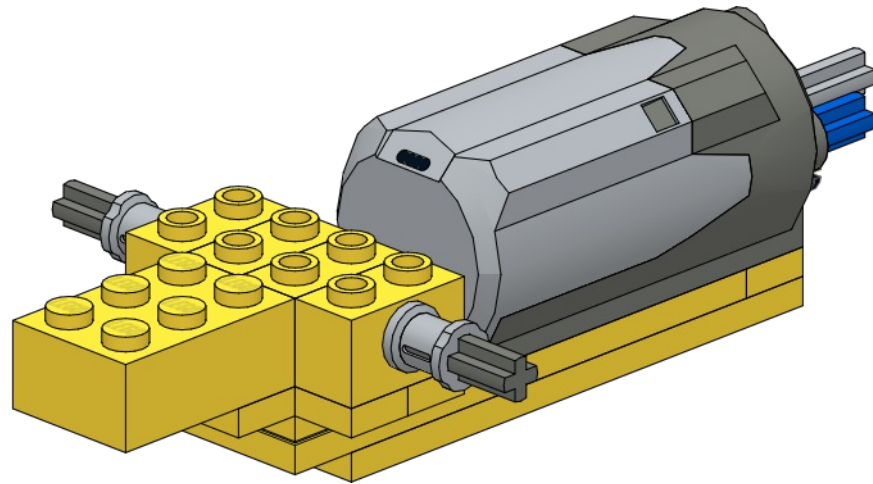
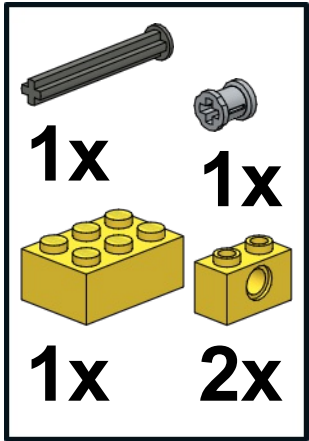

6

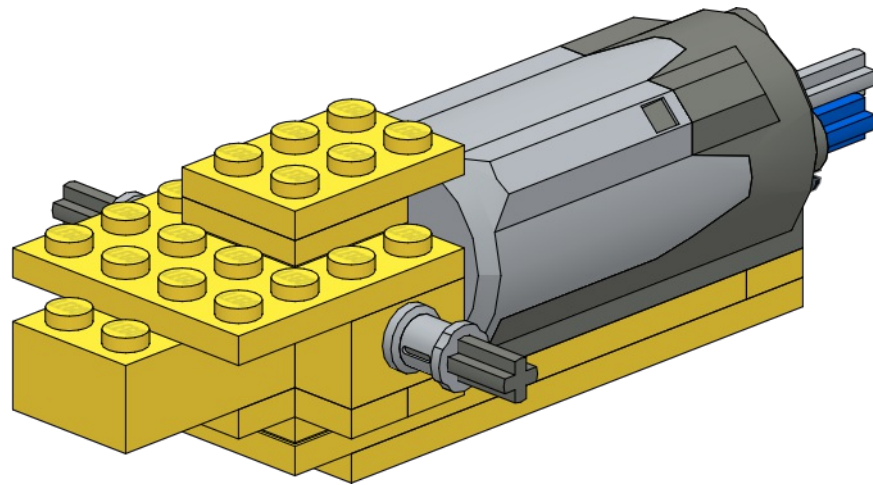
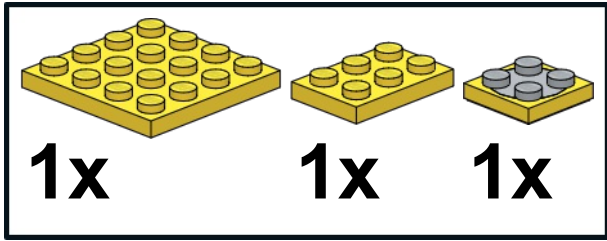

7

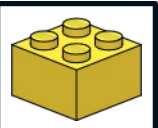

1x

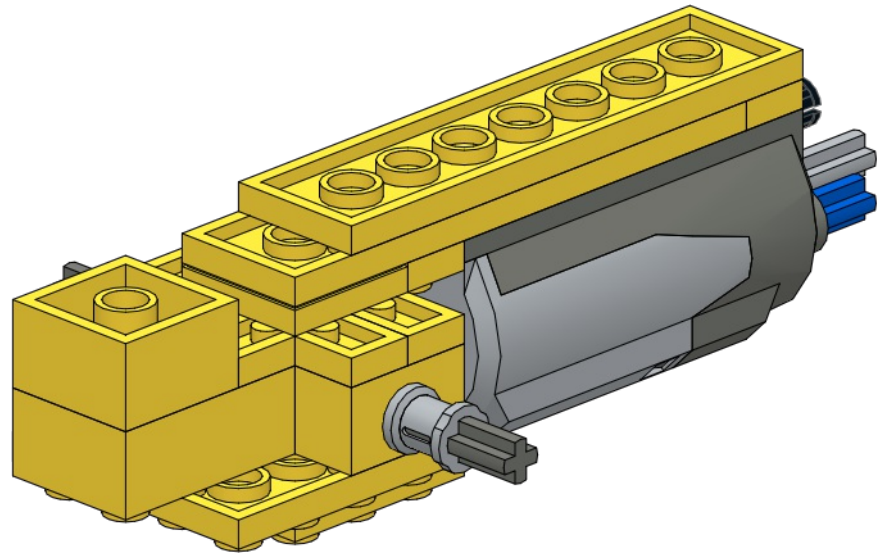

9

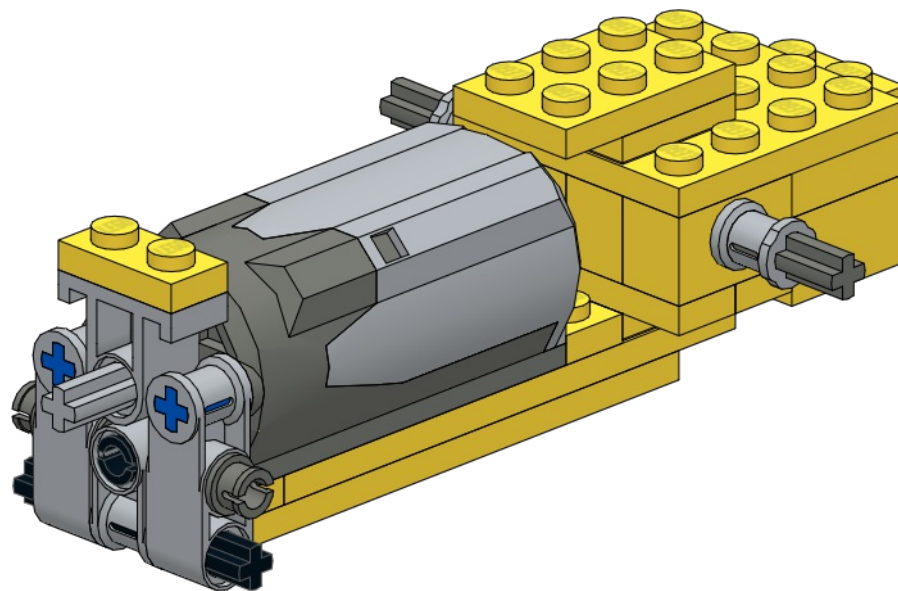
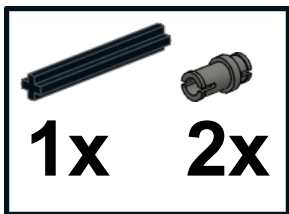

10

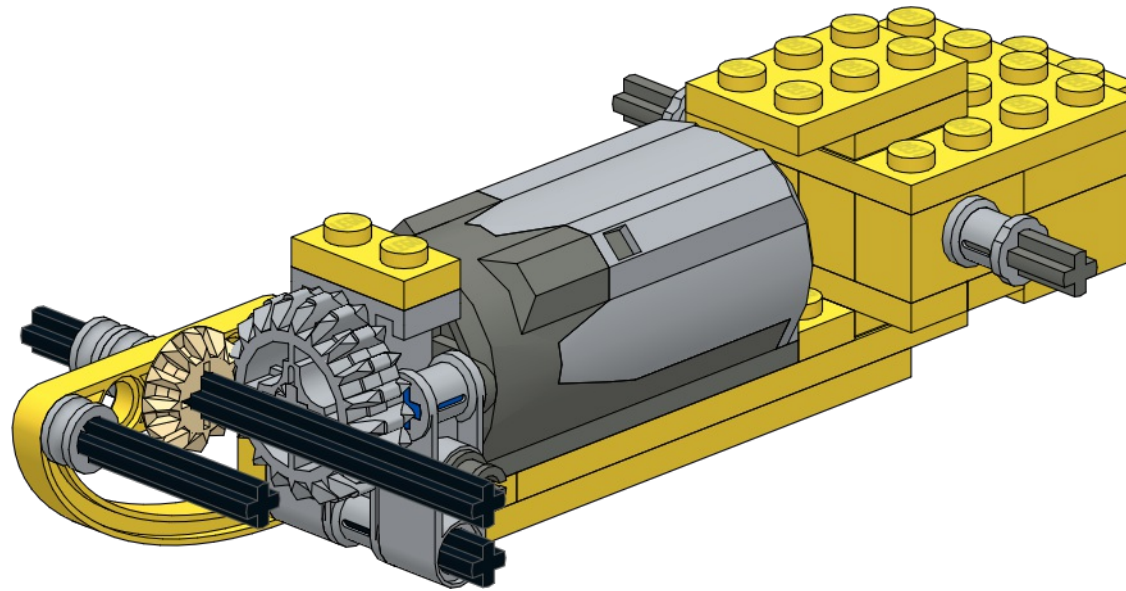
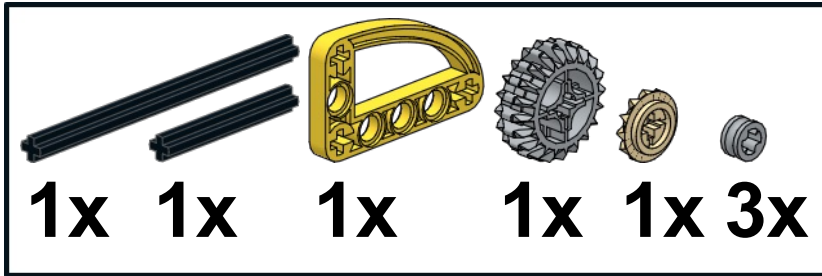

11

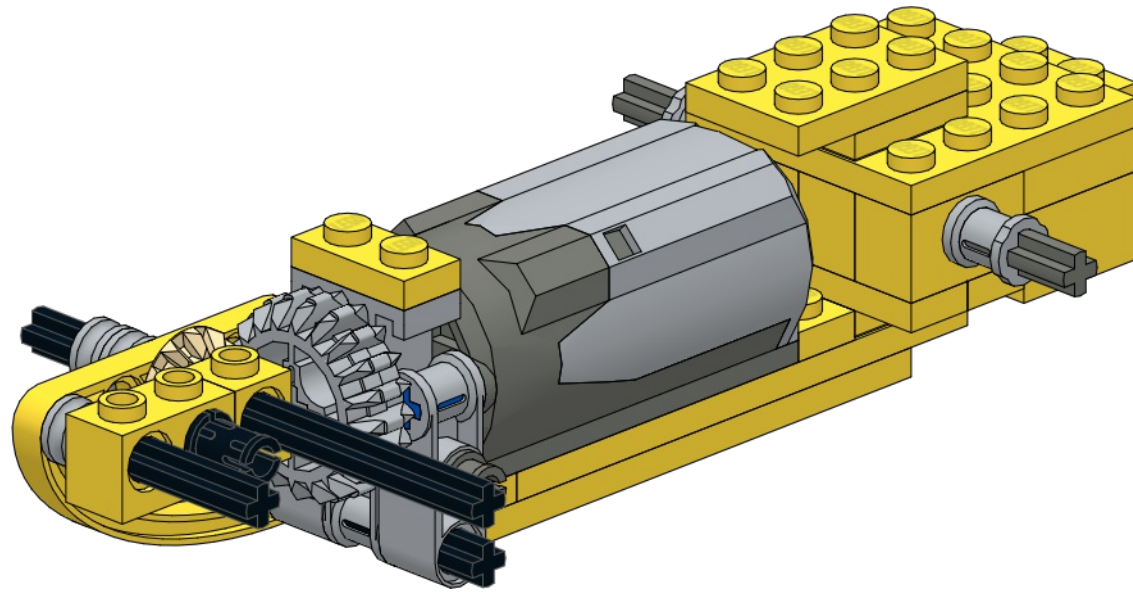
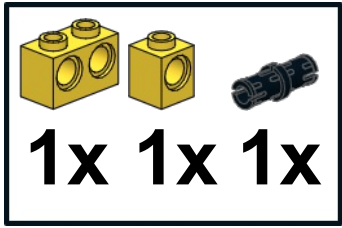

12

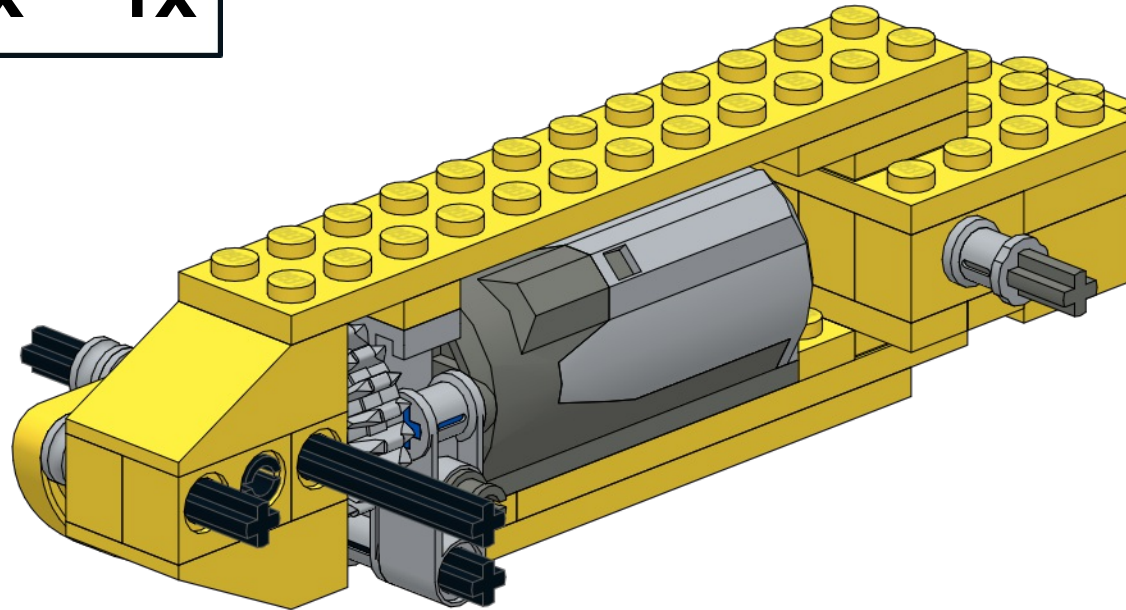
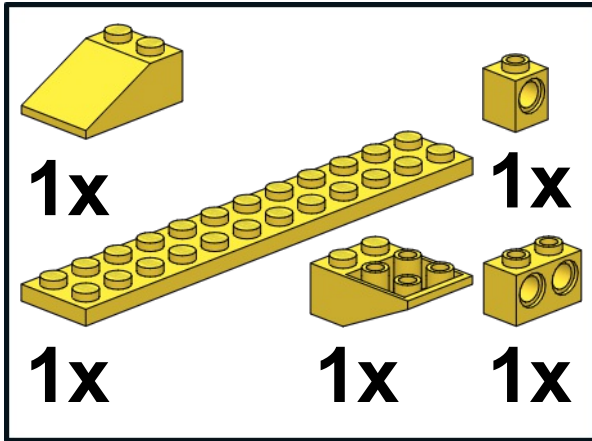

13

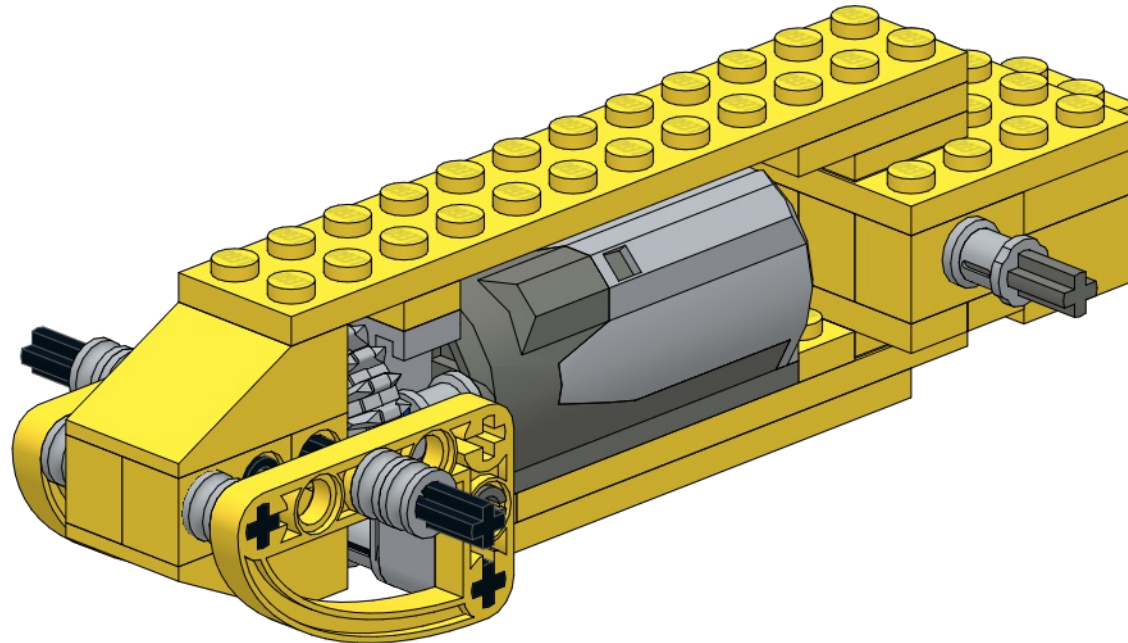
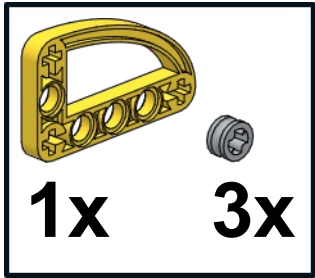

14

